

5100

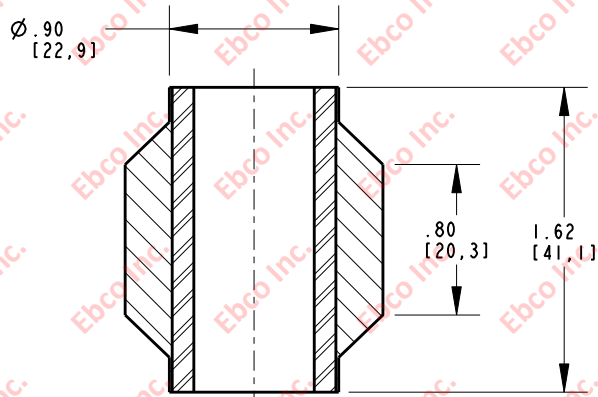

SECTION X-X

INSTALLATION VIEW (Shown under no load)

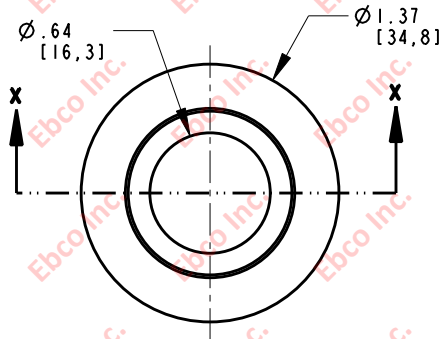
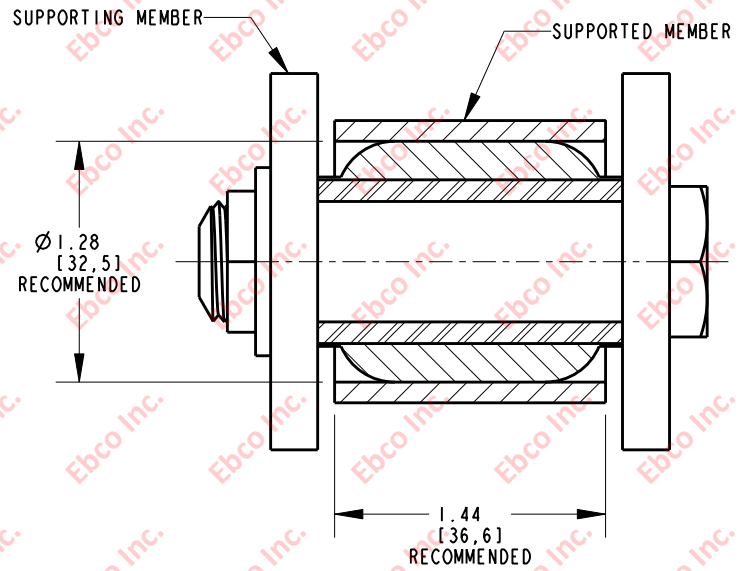

*AVAILABLE IN A VARIETY OF MATERIALS AND STIFFNESS



TITLE: BUSHING, RADIAL	
THE INFORMATION CONTAINED IN THIS DRAWING IS THE SOLE PROPERTY OF EBCO. ANY REPRODUCTION IN PART OR AS A WHOLE WITHOUT THE WRITTEN PERMISSION OF EBCO IS PROHIBITED.	
TOLERANCES PER RMA STANDARD A3	REV. A
DATE: 05-25-11	UNITS: INCH [MM]
1330 HOLMES RD. ELGIN, IL 60123	