

MC5112

DRG NO.

B

A

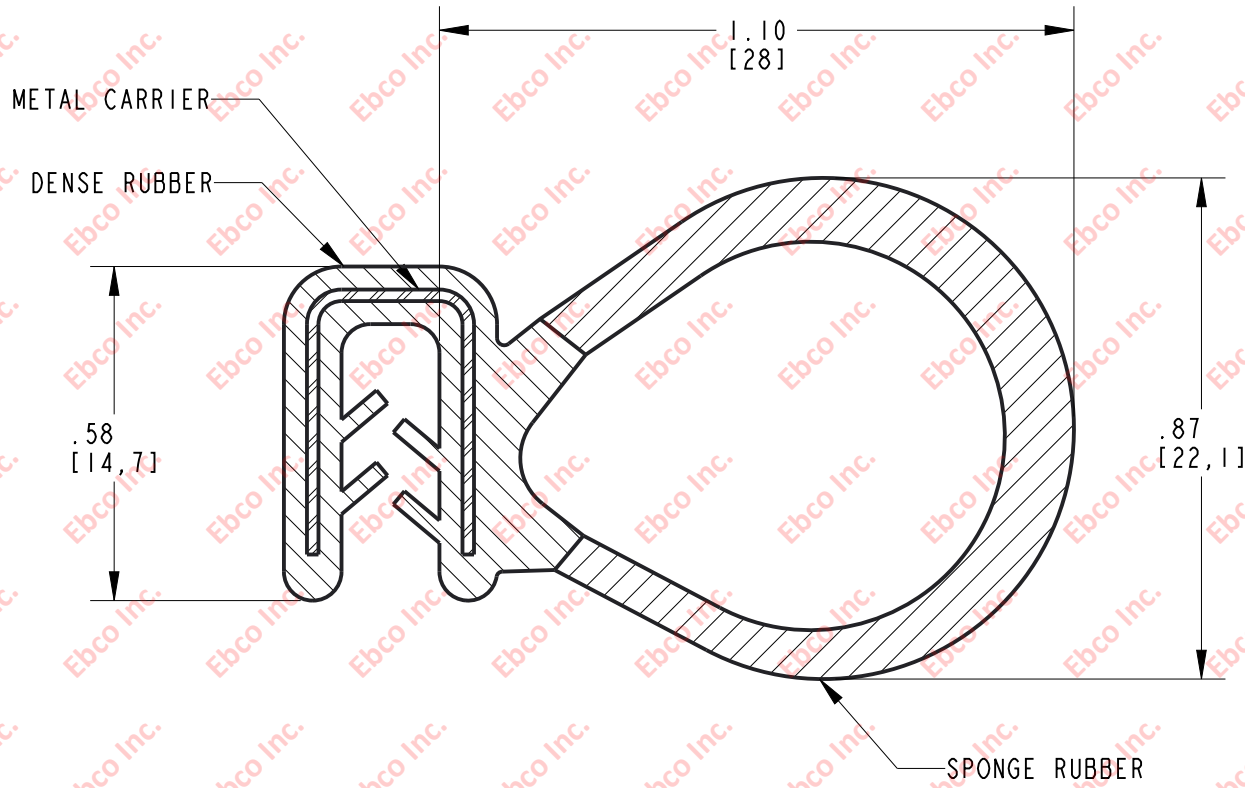

CLAMPING RANGE: .07 [1.85] - .09 [2.39]
 EDGE TRIM: DENSE EPDM
 SEALING BULB: SPONGE EPDM
 METAL CARRIER: STEEL



TITLE: MC5112		
THE INFORMATION CONTAINED IN THIS DRAWING IS THE SOLE PROPERTY OF EBCO ANY REPRODUCTION IN PART OR AS A WHOLE WITHOUT THE WRITTEN PERMISSION OF EBCO IS PROHIBITED.		
TOLERANCES PER RMA STANDARD E3 & BEC2	REV. A	DATE: 07-31-17
		UNITS INCH [MM]

1330 HOLMES RD. ELGIN, IL 60123

SPECIFICATIONS SUBJECT TO CHANGE

2