

MC2100

DWG. NO.

B

A

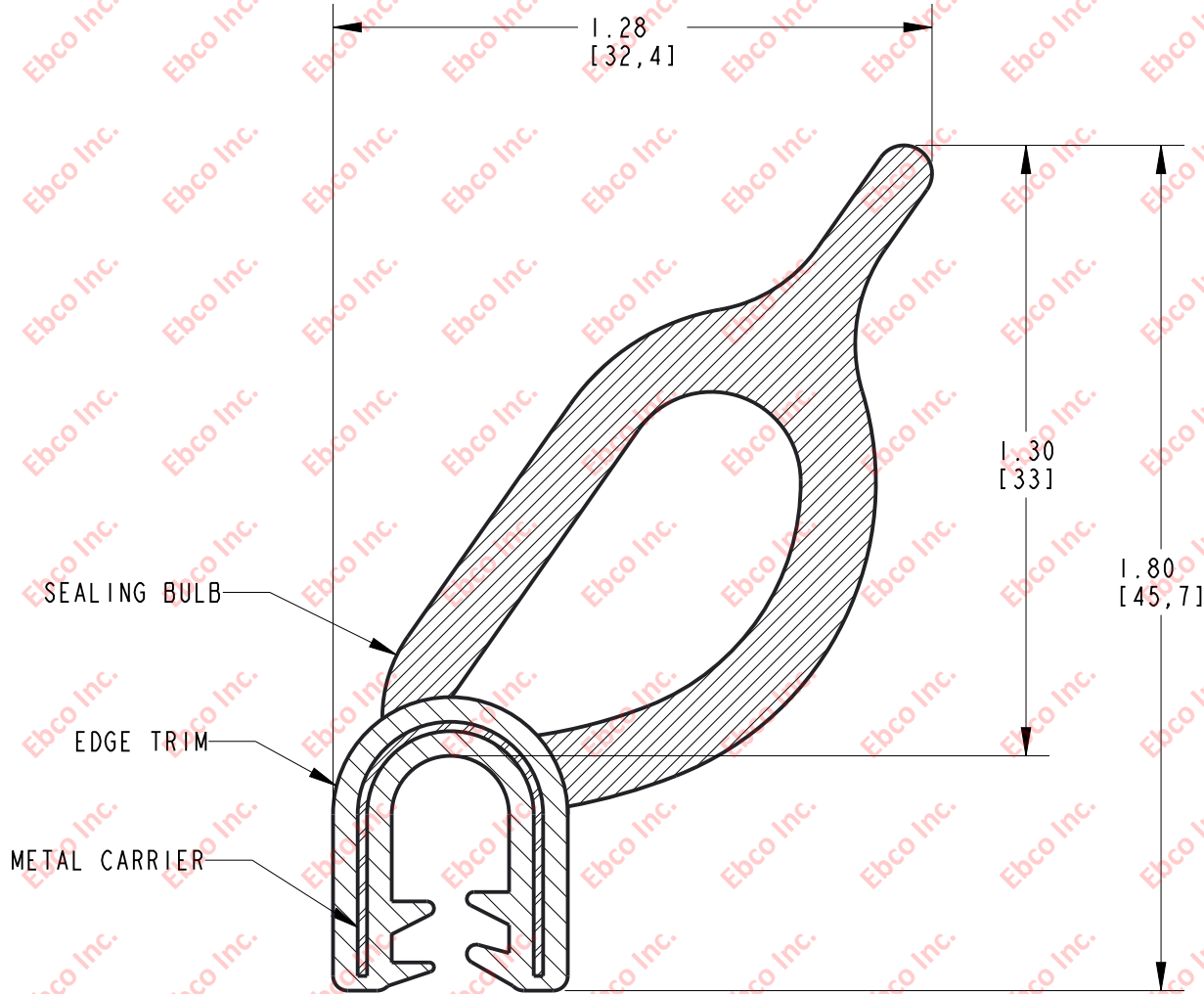

EDGE TRIM: DENSE EPDM
 SEALING BULB: SPONGE EPDM
 METAL CARRIER: STEEL



TITLE: MC2100		
THE INFORMATION CONTAINED IN THIS DRAWING IS THE SOLE PROPERTY OF EBCO. ANY REPRODUCTION IN PART OR AS A WHOLE WITHOUT THE WRITTEN PERMISSION OF EBCO IS PROHIBITED.		
TOLERANCES PER RMA STANDARD E3 & BEC2	REV. A	DATE: 06-10-20
		UNITS: INCH [MM]
1330 HOLMES RD. ELGIN, IL 60123		
SPECIFICATIONS SUBJECT TO CHANGE		

2

B

A