

ES325

DMG NO.

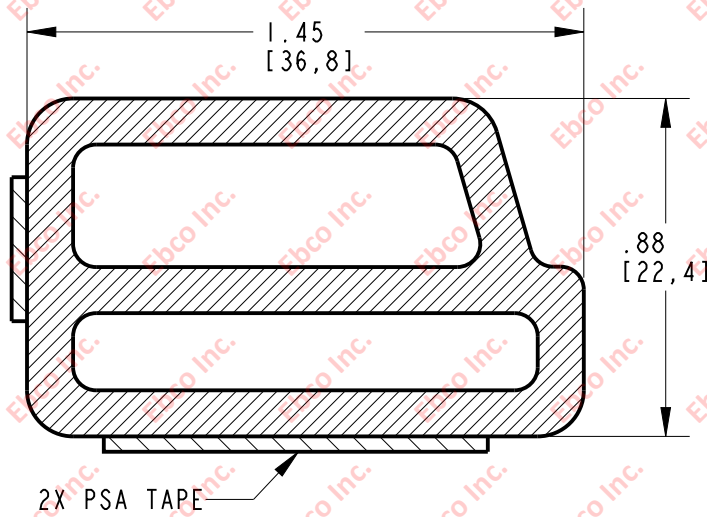

MATERIAL: SPONGE EPDM

	TITLE: ES325		
	<small>THE INFORMATION CONTAINED IN THIS DRAWING IS THE SOLE PROPERTY OF EBCO ANY REPRODUCTION IN PART OR AS A WHOLE WITHOUT THE WRITTEN PERMISSION OF EBCO IS PROHIBITED.</small>		
	TOLERANCES PER RMA STANDARD BEC2	REV. A	DATE: 06-11-20
	UNITS: INCH [MM]		1330 HOLMES RD. ELGIN, IL 60123
SPECIFICATIONS SUBJECT TO CHANGE			