

ER240

DWG. NO.

B

A

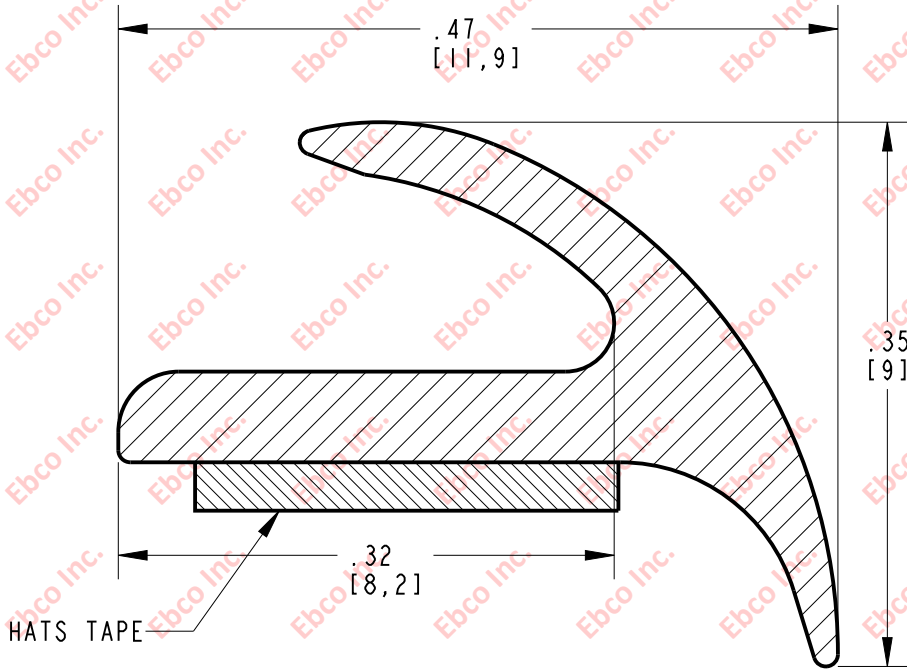

MATERIAL: DENSE EPDM



TITLE: ER240

THE INFORMATION CONTAINED IN THIS DRAWING IS THE SOLE PROPERTY OF EBCO. ANY REPRODUCTION IN PART OR AS A WHOLE WITHOUT THE WRITTEN PERMISSION OF EBCO IS PROHIBITED.

TOLERANCES PER RMA STANDARD E3

REV. A

DATE: 06-10-20
UNITS: INCH [MM]

1330 HOLMES RD. ELGIN, IL 60123

SPECIFICATIONS SUBJECT TO CHANGE

2

B

A