

ER100

DWG. NO.

B

A

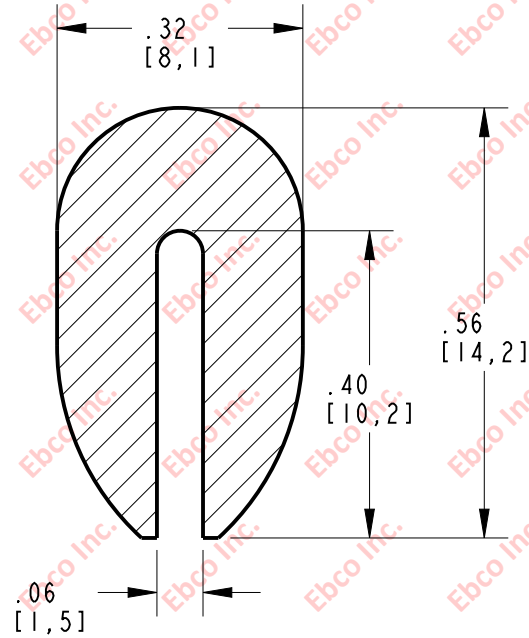

MATERIAL: DENSE EPDM



TITLE: ER100		
THE INFORMATION CONTAINED IN THIS DRAWING IS THE SOLE PROPERTY OF EBCO. ANY REPRODUCTION IN PART OR AS A WHOLE WITHOUT THE WRITTEN PERMISSION OF EBCO IS PROHIBITED.		
TOLERANCES PER RMA STANDARD E3	REV. A	DATE: 06-08-20
		UNITS: INCH [MM]

1330 HOLMES RD. ELGIN, IL 60123

SPECIFICATIONS SUBJECT TO CHANGE

2

B

A